

OEM Motoric Valve Drive: 24 V Proportional

The OEM Motoric Valve Drive: 24 V Proportional is an electromotive actuator for opening and closing valves for heating and cooling systems. The area of application is the energy-efficient control of water-bearing valves in the area of building services and automation.

The OEM Motoric Valve Drive: 24 V Proportional is controlled by a 0-10 V DC control signal of a room thermostat or a building management system. The actuator is equipped with a LC display with background illumination for displaying the current stroke, the control voltage, and the operating modes (open/close), as well as for the output of error codes. The actuator is equipped with a plug-in connection line as well as with a manual valve setting which can be used e. g. for maintenance or installation purposes. Optionally a variant with Feedback- Signal is available. This signal gives information about current valve position and status evidences to a BMS- System.

The actuator has been specially developed for the customer-specific use in OEM businesses. The modular structure offers diverse differentiation possibilities for customer-specific designs.



1.1 Features

- OEM design
- Operating voltage 24 V, appropriate for AC and DC operation
- Stroke from 2 to 8.5 mm (parametrisable in factory)
- Force in the variants 100 N, 125 N, 150 N or 200 N
- LC-Display for status indication
- Function display via LED
- Characteristic linearisation (optional)
- Variable, continuous valve positioning
- Very short response times
- Maximum energy efficiency due to complete motor control via micro controller.
- Self-locking gear in all positions, de-energized
- Antitheft function by removable locking latch
- Force-dependent deactivation in case of overload or when the final stop resp. the closing position is reached
- Manual valve setting
- Very low power consumption
- Valve adapter system
- Simple plug-in installation without tools
- 100 % protection in case of leaky valves (IP 54)
- 360° installation position
- Plug-in connecting cable
- Low-noise and maintenance-free
- Variants in stroke and regulation time
- Control input suitable for 0 – 10 V and pulse width modulation (PWM)
- Optional: Feedbacksignal 0-10 V
- Optional: Valve stroke recognition

1.2 Variants

In its basic version, the OEM Motoric Valve Drive: 24 V Proportional is delivered without logo, with plug-in connection cable and retracted valve pressure plate. The following variant is available in the basic version.

Type	Operation voltage	Stroke	Force	Regulating time	Control voltage	Scope of supply
MPR 46805-20	24 V AC/DC	8,5 mm	100 N	30 s/mm	0-10 V	<ul style="list-style-type: none"> • Motoric Valve Drive: MPR in individual packaging • 1 m connection line (plug-in), white, PVC 3 x 0.22 mm² • Installation instruction in 12 languages
MPR 46825-20			125 N			
MPR 46835-20			150 N			
MPR 46845-20			200 N			
MPV 46805-20	24 V AC/DC	8,5 mm	100 N	30 s/mm	0-10 V	<ul style="list-style-type: none"> • Motoric Valve Drive: MPV in individual packaging • 1 m connection line (plug-in), white, PVC 3 x 0.22 mm² • Installation instruction in 12 languages
MPV 46825-20			125 N			
MPV 46835-20			150 N			
MPV 46845-20			200 N			
MPO 46805-20	24 V AC/DC	8,5 mm	100 N	30 s/mm	0-10 V	<ul style="list-style-type: none"> • Motoric Valve Drive: MPO in individual packaging • 1 m connection line (plug-in), white, PVC 4 x 0.22 mm² • Installation instruction in 12 languages
MPO 46825-20			125 N			
MPO 46835-20			150 N			
MPO 46845-20			200 N			

Additional Variants:
 MPx xxxxx-x1 = 2- 10 V
 MPx xxxxx-x2 = 10- 0 V
 MPx xxxxx-3x = 15 s/mm

1.3 The following extension possibilities resp. differentiations from basic version are available optionally

Line lengths	2 m, 3 m, 5 m, 10 m, 15 m; PVC in white – 3 or 4 x 0.22 mm ² - special lengths up to 20 m, for plug-in
Valve adapters	Available for almost all valves
Packaging	Packaging can be manufactured and printed individually according to requirements.
Imprint on casing	Imprint of the company logo and the individual type designation
Please contact us if you have further wishes.	

1.4 Equipment

The OEM Motoric Valve Drive: 24 V Proportional is available in different variants, which have different functionalities

	MPR 468x5	MPV 468x5	MPO 468x5
LC-Display	✓	✓	✓
Backlight	optional	optional	optional
Status Display via LED	✓	✓	✓
Valve stroke recognition		✓	✓
Feedbacksignal 0-10V			✓
Manuel Valve Setting	✓	✓	✓

2 Function

The control of the OEM Motoric Valve Drive: 24 V Proportional is performed by a 0-10 V DC control signal from a room thermostat or a building management system. After switching on the power supply, the actuator initializes. In the initialization of the actuator determines the mechanical stroke of the actuator. In this period the display alternately shows "In" (for initialization) and the control voltage applied to. Other descriptions for initialization includes the chapter on actuator

- ↳ **MPR 46xx5:** 2.1 Initialization (MPR 468x5)
- ↳ **MPV/MPO 46xx5:** 2.2 Initialization (MPV/ MPO 468x5)

2.1 Initialization (MPR 468x5)

First, the valves pressure plate is fully retracted, whereby the upper end-stop of the drive is determined. Following the valve plate extends fully and determined the bottom end stop, the closing point of the valve and this point of the valve is detected. If a control voltage is applied, the actuator opens the valve smoothly. The drive is calculating from control voltage and actuator travel the needed position and move to it precisely.

Note:

For initialization the MPR needs max. 7 minutes

2.2 Initialization (MPV/ MPO 468x5)

First, the valves pressure plate is fully retracted, whereby the upper end-stop of the drive is determined. Following the valve plate extends fully and determined the bottom end stop, the closing point of the valve and this point of the valve is detected. Now the valve stroke recognition will happen. Therefor the actuator moves with high speed to the upper position and back to the lower position slowly, for determining the valve stroke. In case of not sensing the valve, the actuator will work with the factory setting stroke (8.5 mm).

The stroke of the valve can be changed in practice by different conditions. The valve was adjusted, or the actuator was mounted to a new valve. In both cases, the data obtained at the initialization values has changed. Thus, the actuator adjusts to the new valve stroke, the power supply and the control voltage must be interrupted briefly. After the power has been switched on again, the actuator performs a new initialization phase.

Note:

For initialization the MPV/MPO needs max. 15 minutes

2.3 Operation

The control of the OEM Motoric Valve Drive: 24 V Proportional is performed by a 0-10 V DC control signal from a room thermostat or a building management system. The control signal allows a precise activation and positioning of the actuator. A 0 - 10 V or PWM signal can be applied to the control voltage input for control purposes.

Note

1. Using poppet valves with soft rubber seal the pressing of the sealing will be determined as a valve stroke.
2. The following diagrams are only valid, when the correct valve adapterring is chosen:

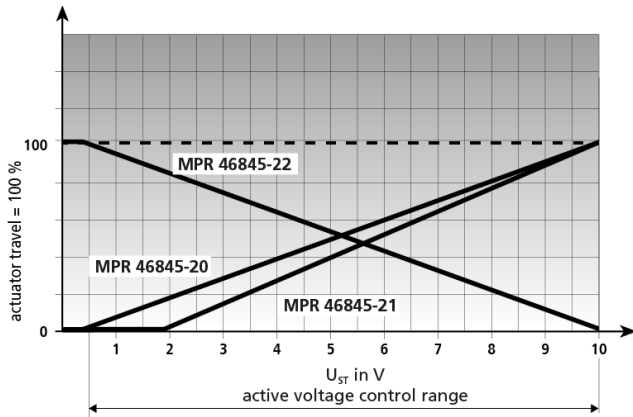

Functionality-diagram: MPR 468x5

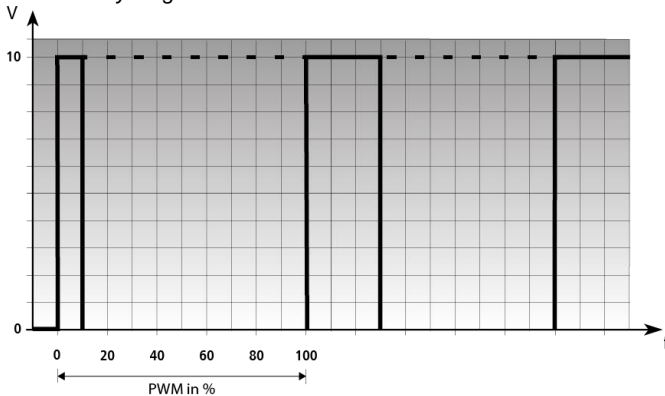

PWM: Pulse width frequency 100 to 1.000 Hz

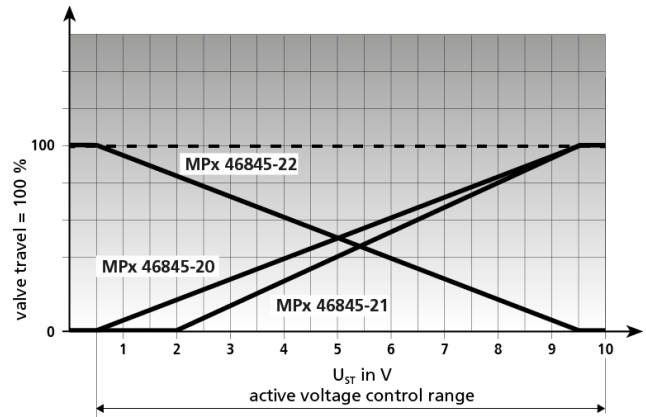

Functionality-diagram: MPV/MPO 468x5

2.4 Optional: Feedback Signal (MPO)

The Feedback Signal of the OEM Actuator 5: Proportional MPO allows a direct feedback of the current operating status. Voltages of 1 to 9 volts supply information about the actuator position, voltages < 0.5 V and > 9.5 V point to possible errors. The feedback channel emits a voltage proportional to the actuator path position:

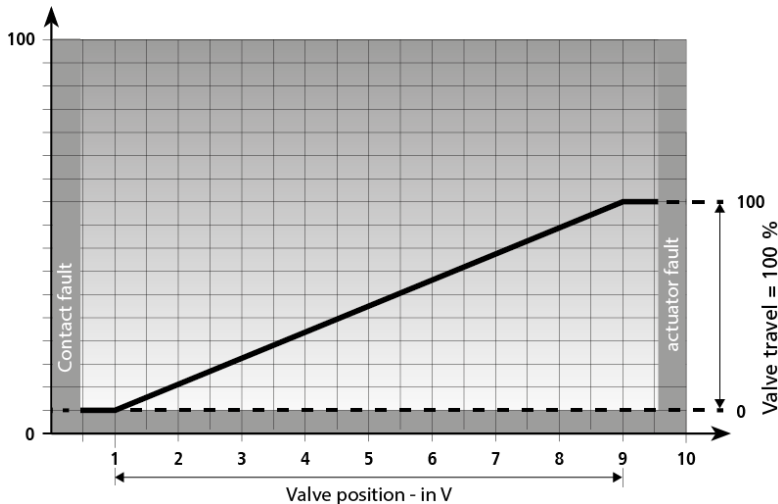

Voltage	Description
< 0.5 V	No function or no contacting
1 V to 9 V	voltage emitted proportionally to the valve path
1 V	corresponds to a closed valve
9 V	corresponds to an open valve
> 9.5 V	Internal error

2.5 Manuel Valve Setting

The manual valve setting allows to bring the valve pressure plate to the desired position in de-energised status. This facilitates e. g. maintenance and installation.

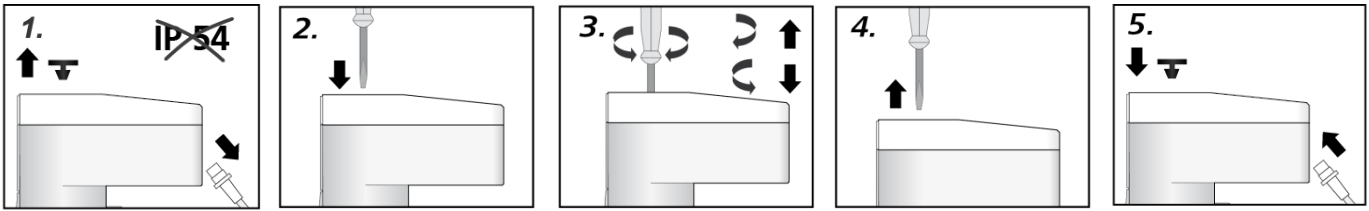

1. Remove the protective plug and the connection line, or switch off the voltage supply.

2. Introduce a screwdriver (0.3 x 2 mm) into the manual valve setting device.

3. Turn to the right or left for extracting or retracting, respectively.

4. Remove the screwdriver after reaching the desired position.

5. Install the protective plug and connect the connection line.

2.6 Function display via LED

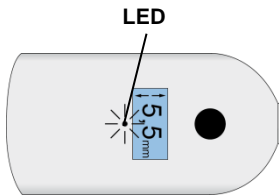

The OEM Motoric Valve Drive: 24 V Proportional is equipped with a multi-coloured LED for the signalling of operating statuses. Green and red are used as signal colours. Signalling is only performed if the valve drive is supplied with operating voltage. Error conditions are indicated with steady red light.

2.7 LC-Display

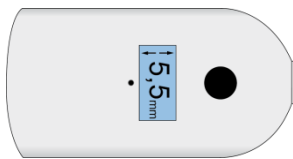

The LC display of the OEM Motoric Valve Drive: 24 V Proportional alternately shows the setting position and the applied control voltage. In case of a control requirement, the current driving direction is shown in the LC display by means of an arrow. In case of an error, the corresponding error code is shown and the error is indicated by a steadily lighted LED.

Note
The mechanical play between actuator and valve adapter and the gear in the actuator is recognized as valve travel. This affects the position indicator and the control bandwidth is minimally reduced. In contrast to the actual valve stroke, thus an approximately 1 mm higher valve stroke is shown in the display.

2.8 Error codes

Queued errors are indicated by an error code. The subsequent table explains the different error codes and error corrections.

Error code	Description	Error correction
E6	Irregular position is determined	The actuator has to be disconnected from the power supply and the control shaft must be moved with the manual setting from the end position. After the power resumes, the initialization starts again. If the error recurs, the customer service is to be called.
E8	Indicates an internal error	The actuator will perform a re-initialization after 10 seconds. If the error cannot be corrected automatically after a maximum of three attempts, there is a permanent error displayed. In this case, the customer service is to be called.

2.9 Antitheft device

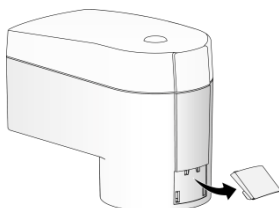

The OEM Motoric Valve Drive: 24 V Proportional can be protected against unauthorised access by a simple removal of the locking latch.

3 Technical Data

Type	MPR 468x5	MPV 468x5	MPO 468x5
Operating Voltage	24 V AC, -10 %... +20 %, 50-60 Hz 24 V DC, -20 %... +20 %		
Operating Power	2,6 VA/ 1,4 W		
Max. power consumption	< 110 mA		
Standby power consumption	< 10 mA		
Impedance of control voltage input	100 kΩ		
Feedback Signal	Voltage	0 V ... 10 V DC	
	Current	1 mA	
	Load impedance	10 kΩ–1000 kΩ	
	Resolution	0,1 V	
Stroke	Standard	Max. 8,5 mm	
	Factory setting	2 mm to 8,5 mm	
Force	Standard	100 N -20/+40%	
	Variants	125, 150, 200 N -20/+40%	
Regulating time	Standard	30 s/mm	
	Variants	15 s/mm	
LCD (H x W)	10 x 20 mm, optional with blue backlight		
LED	multicoloured-LED		
Storage temperature	-20 °C bis +70 °C		
Ambient temperature	0 °C bis +50 °C		
Degree of protection	IP 54 ¹⁾		
Protection class	III		
CE-conformity according to	EN 60730		
Casing	Material	Polyamide	
	Colour	Light grey (RAL 7035), from 2016 White (RAL 9003)	
Casing cover	Material	Polycarbonate	
	Colour	Transparent	
Cable	Type	3 x 0,22 mm ² PVC	4 x 0,22 mm ² PVC
	Colour	white	
	Length	1 m	
Weight with cable (1 m)	155 g		
Weight without cable (1 m)	130 g		
Surge strength according to EN 60730-1	1 kV		

1) in all positions

3.1 Dimensions

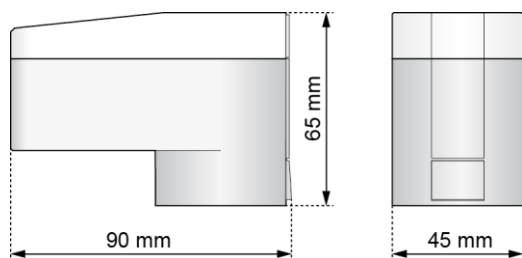

3.2 Certifications



Additionally Motoric Valve Drive: Proportional 24 V is certified according to NRTL by TÜV Süd.

4 Installation notes

4.1 Installation positions

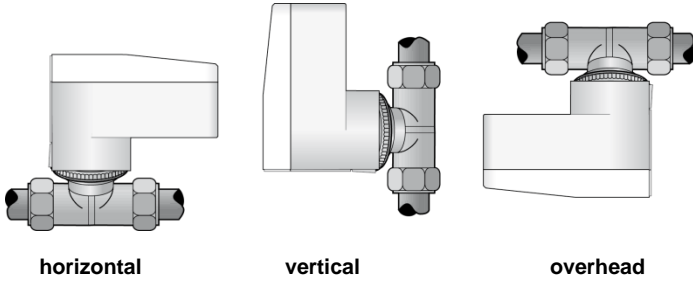

The OEM Motoric Valve Drive: 24 V Proportional can be operated in every installation position.

4.2 Installation with valve adapter

ATTENTION!

Installation with extracted valve pressure plate leads to actuator damage.

- Only install the actuator with completely retracted valve pressure plate.
- Retract an extracted valve pressure plate with the manual valve setting, or electrically.

The OEM Motoric Valve Drive: 24 V Proportional is installed to the valve with a valve adapter. An extensive valve adapter assortment guarantees a perfect mechanical match of the actuator to almost all valves available on the market. The actuator is simply plugged onto the valve adapter previously installed manually. The fact that the valve pressure plate is retracted in factory, allows for easy installation.

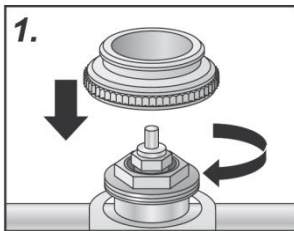

1. Screw the valve adapter manually onto the valve.

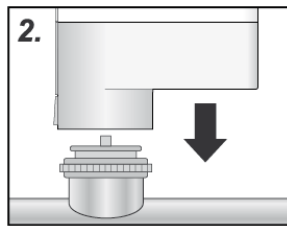

2. Position the actuator manually in vertical position to the valve adapter.

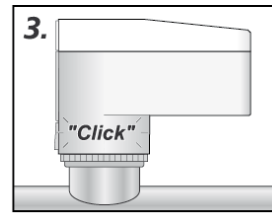

3. Simply latch the actuator manually by applying vertical pressure; a clicking sound can be heard.

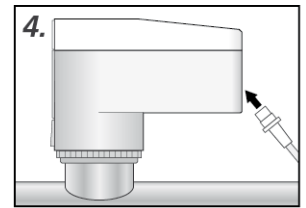

4. Connect the connection line to the actuator.

4.3 Electric Connection 24 V AC/DC L1 (+) L2 (-)

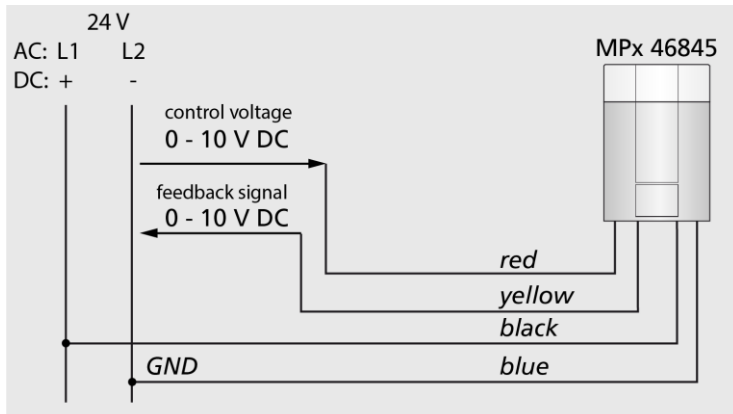

Connection line

We recommend the following maximum cables for installing a 24 V system:

Cable	Section	Max. length
Standard line	0.22 mm ²	20 m
J-Y(ST)Y	0.8 mm	45 m
NYM / NYIF	1.5 mm ²	136 m

Transformer/power supply:

A safety isolating transformer according to EN 61558-2-6 (for AC supply) or a switching power supply according to EN 61558-2-16 (for DC supply) must always be used.

The dimensioning of the transformer, or the switching power supply, results from the maximum operating power of the OEM Actuators.

Technical changes reserved. Reprint, including partial reprint, only with the approval of Möhlenhoff GmbH.